

SB54x32-SSB-LC

54 X 32 SHOWER BASE WITH CENTER DRAIN IMI LITECAST™

Note: Base dimensions may vary +/- 1/4"

* Also available in IMI ProCast™



Material to be crated and stacked on pallets.



Cast Marble Solutions

COLOR & TRIM OPTIONS

Standard Color	Code
White	SW

Optional Color	Code
Cream	SC
Ivory	SI
Warm White	WW



FEATURES

- **Shower base size:** 54" x 32"
- **Curb size:** 3" x 3"
- **Construction:**
 - * Solid one piece
 - * Pre-levleled
 - * Rests on the subfloor
 - * Grout-free
 - * Non-porous
 - * Water & Leak-proof
- **Resistant to:**
 - * Bacteria
 - * Mold and mildew
 - * Stains (easy to clean)
- **Flange:** Industrial composite (attached in our factory)

STANDARDS AND RATINGS

- Typical CSI Code: 22 42 23 (Div 22)
- Complies with ANSI Z124 Test
- Complies with ASTM F 462 (Anti-slip test), Our lowest value read was 0.07, test requires 0.04
- MAS Certified Green
- ASTM (Fire rating)

Code compliant when fully equipped and installed according to guidelines.



SB54x32-SSB-LC

54 X 32 SHOWER BASE WITH CENTER DRAIN
IMI LITECAST™

Top View

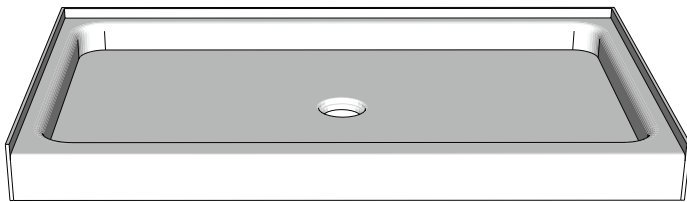
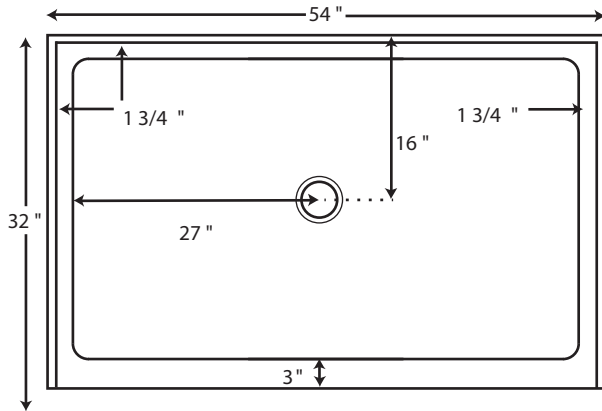

Flange Details: (U.S.)

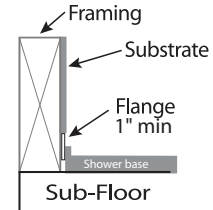

Drain Details: (U.S.)

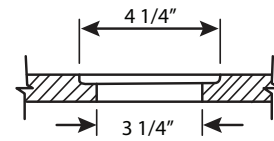

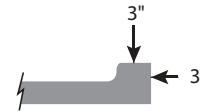

Side View of Curb



FEATURES: Dimensional Tolerance $\pm 1/4"$. Dimensions needed for site preparation should be measured from the unit. American Bath Group assumes no responsibility for preparatory work.

Type and Model #	Material	Shower Base	Pieces
Shower Base #SB54x32-SSB-LC	Cast Marble	Anti-Slip/Textured Finish	1

SUGGESTED DRAINS

Image	Description
	Solvent Weld type fitting similar to Oatey Part No. 42097
	Compression type "No-Caulk" fitting similar to Oatey Part No. 42099

Drains are not sold by IMI

Rev. 01.2024