

SB60x30-LP-8.5TD-xH-LC

inches

60 X 30 ADA ROLL-IN LH OR RH SHOWER BASE
WITH 8.5" LOW PROFILE TRENCH DRAIN
IMI LITECAST™

Exterior Dimensions: 60W x 30D

Note: Base dimensions may vary +/- 1/8"

* Also available in IMI ProCast™

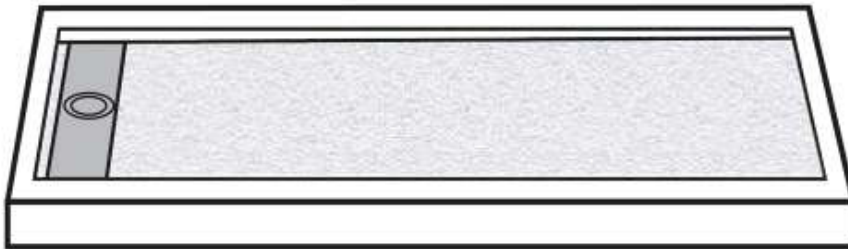

FEATURES

- Fiberglass Flange
- Left or right drain
- Pre-sloped to drain
- Solid one-piece construction
- Pre-leveled, rests on subfloor
- Mold and mildew resistant
- Bacteria resistant
- "Grout-free" and non-porous
- Stain resistant and easy to clean
- Waterproof and leakproof

STANDARDS AND RATINGS

- Typical CSI Code: 22 42 23 (Div 22)
- ANSI
- ASTM (Fire Rating)
- MAS Certified Green

Code compliant when fully equipped and installed according to guidelines.

Material to be stacked on pallets.

DRAIN FINISHES

Solid Cover	Code
Brushed Stainless Steel	SS
Ornamental (Slotted)	OSS
Decorative (Perforated)	DSS
Powder Coated	W, MB

COLOR & TRIM OPTIONS

Standard Color	Code
White	SW

Optional Color	Code
Cream	SC
Ivory	SI
Warm White	WW

Additional custom colors available.



Cast Marble Solutions



SB60x30-LP-8.5TD-xH-LC

60 X 30 ADA ROLL-IN LH OR RH SHOWER BASE
WITH 8.5" LOW PROFILE TRENCH DRAIN

IMI LITECAST™

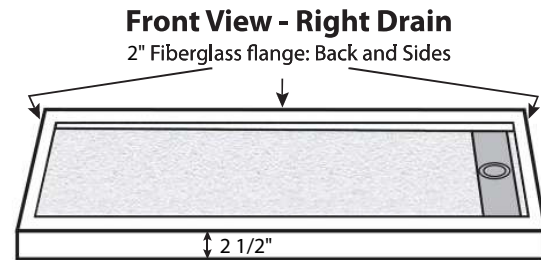
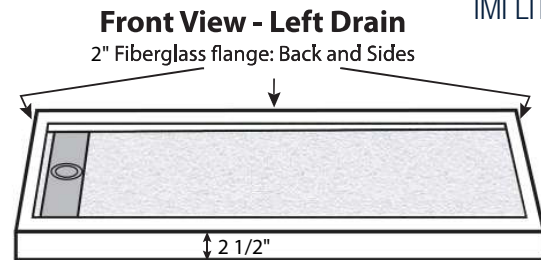
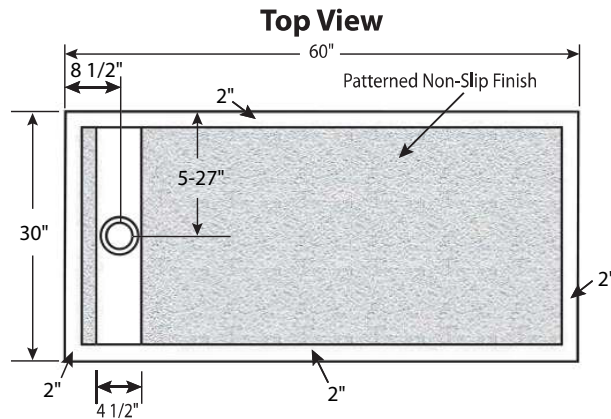

Side View of Curb

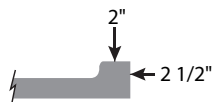

Drain Details: (U.S.)

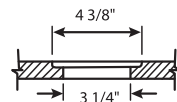

Drain Cover



Flange Details: (U.S.)

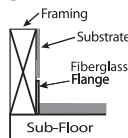

FEATURES Dimensional Tolerance $\pm 1/8"$. Dimensions needed for site preparation should be measured from the unit. American Bath Group assumes no responsibility for preparatory work.

Type and Model #	Material	Shower Base	Pieces
Shower Base #SB60x30-LP-8.5TD-xH-LC	Cast Marble	Anti-Slip/Textured Finish	1

DIMENSIONS

Specifications	inches
Shower Base Depth:	30
Shower Base Width:	60
Curb Height:	2 1/2
Curb Width:	2

Suggested Drains:



Solvent Weld type fitting similar to Oatey Part No. 42097



Compression type "No-Caulk" fitting similar to Oatey Part No. 42099