

# SB54x36-SSB-LC

inches

## 54 X 36 STANDARD SHOWER BASE WITH CENTER DRAIN IMI LITECAST™

Exterior Dimensions: 54W x 36D

Note: Base dimensions may vary +/- 1/8"

\* Also available in IMI ProCast™

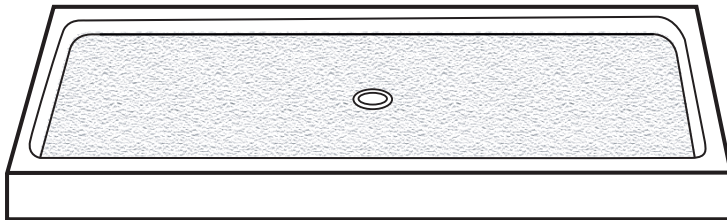

Material to be stacked on pallets.

### COLOR & TRIM OPTIONS

Standard Color	Code
White	SW

Optional Color	Code
Cream	SC
Ivory	SI
Warm White	WW

Additional custom colors available.



Cast Marble Solutions

### FEATURES

- Solid one-piece construction
- Pre-leveled, rests on subfloor
- Mold and mildew resistant
- Bacteria resistant
- “Grout-free” and non-porous
- Stain resistant and easy to clean
- Water proof and leak proof

### STANDARDS AND RATINGS

- Typical CSI Code: 22 42 23 (Div 22)
- ANSI
- ASTM (Fire Rating)
- MAS Certified Green

Code compliant when fully equipped and installed according to guidelines.



# SB54x36-SSB-LC

54 X 36 STANDARD SHOWER BASE WITH CENTER DRAIN  
IMI LITECAST™

## Top View

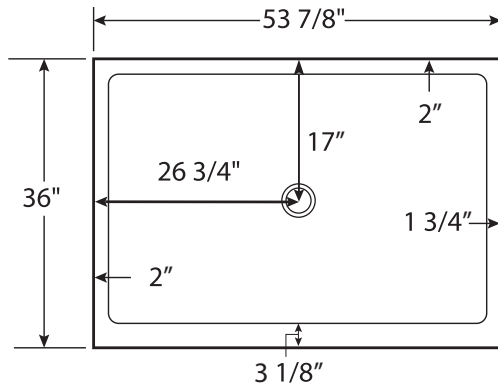

## Front View

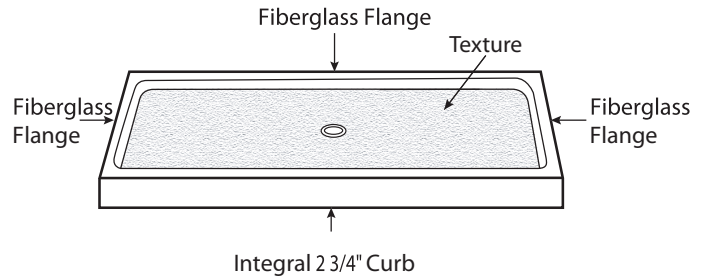

### Drain Details: (U.S.)

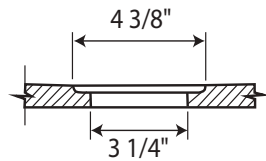

### Flange Details: (U.S.)

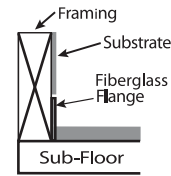



**FEATURES** Dimensional Tolerance  $\pm 1/8"$ . Dimensions needed for site preparation should be measured from the unit. American Bath Group assumes no responsibility for preparatory work.

Type and Model #	Material	Shower Base	Pieces
Shower Base #SB54x36-SSB-LC	Cast Marble	Anti-Slip/Textured Finish	1

## DIMENSIONS

Specifications	inches
Shower Base Depth:	36
Shower Base Width:	53 7/8
Curb Height:	2 3/4

## SUGGESTED DRAINS

Image	Description
	Solvent Weld type fitting similar to Oatey Part No. 42097
	Compression type "No-Caulk" fitting similar to Oatey Part No. 42099

Rev. 04.12.21