

SB48x36-SSB-LC

inches

48 X 36 STANDARD SHOWER BASE WITH CENTER DRAIN

IMI LITECAST™

Exterior Dimensions: 48W x 36D

Note: Base dimensions may vary +/- 1/8"

* Also available in IMI ProCast™

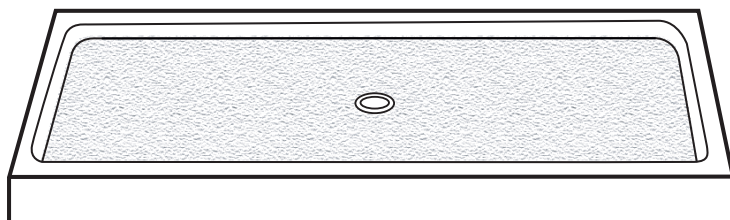

FEATURES

- 3" wide x 2 3/4" tall curb
- Fiberglass flange
- Solid one-piece construction
- Pre-leveled, rests on subfloor
- Mold and mildew resistant
- Bacteria resistant
- "Grout-free" and non-porous
- Stain resistant and easy to clean
- Water proof and leak proof

STANDARDS AND RATINGS

- Typical CSI Code: 22 42 23 (Div 22)
- ANSI
- ASTM (Fire Rating)
- MAS Certified Green

Code compliant when fully equipped and installed according to guidelines.

Material to be stacked on pallets.

COLOR & TRIM OPTIONS

Standard Color	Code
----------------	------

White	SW
-------	----

Optional Color	Code
----------------	------

Cream	SC
Ivory	SI
Warm White	WW

Additional custom colors available.



Cast Marble Solutions



SB48x36-SSB-LC

48 X 36 STANDARD SHOWER BASE WITH CENTER DRAIN
IMI LITECAST™

Top View

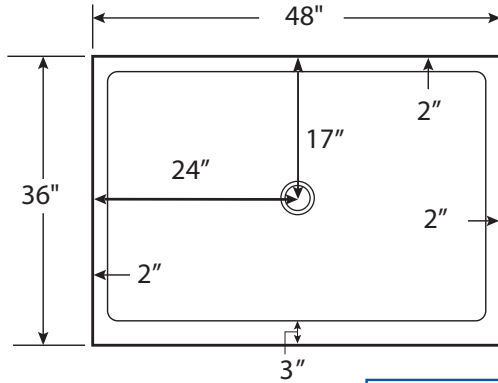

Front View

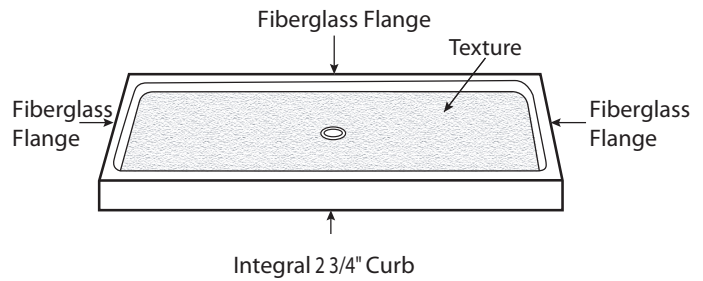

Drain Details: (U.S.)

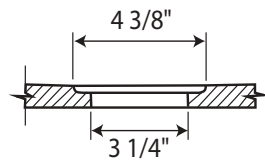

Flange Details: (U.S.)

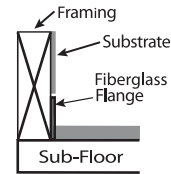



FEATURES Dimensional Tolerance $\pm 1/8"$. Dimensions needed for site preparation should be measured from the unit. American Bath Group assumes no responsibility for preparatory work.

Type and Model #	Material	Shower Base	Pieces
Shower Base #SB48x36-SSB-LC	Cast Marble	Anti-Slip/Textured Finish	1

DIMENSIONS

Specifications	inches
Shower Base Depth:	36
Shower Base Width:	48
Curb Height:	2 3/4

SUGGESTED DRAINS

Image	Description
	Solvent Weld type fitting similar to Oatey Part No. 42097
	Compression type "No-Caulk" fitting similar to Oatey Part No. 42099

Rev. 04.12.21